

KOMATSU®

WA500-6

WA
500

HORSEPOWER

Gross: 266 kW 357 HP / 1900 min⁻¹

Net: 263 kW 353 HP / 1900 min⁻¹

OPERATING WEIGHT

33220 – 34540 kg

BUCKET CAPACITY

4.3 – 5.6 m³



Photos may include optional equipment.

WALK-AROUND





HIGH PRODUCTIVITY & LOW FUEL CONSUMPTION

- ▮ Precision Control with Closed-center Load Sensing System (CLSS) Hydraulics
- ▮ Faster Travel & Lower Fuel Consumption
- ▮ Advanced Power Train
- ▮ Maximum Dumping Clearance and Reach

INCREASED RELIABILITY

- ▮ Komatsu Designed Components
- ▮ High-rigidity Frames and Loader Linkage
- ▮ Wet Multiple-disc Brakes and Fully Hydraulic Braking System

EXCELLENT OPERATOR ENVIRONMENT

- ▮ Pillar-less Large Cab
- ▮ Best Position for Comfort
- ▮ Automatic Transmission
- ▮ Easy & Simple Operation

EASY MAINTENANCE

- ▮ Easy Radiator Cleaning
- ▮ Equipment Management Monitoring System
- ▮ Maintenance Accessibility

SAFETY

- ▮ ROPS/FOPS Cab (ISO 3471/ISO 3449)
- ▮ Rear-hinged Full Open Cab Door

KOMTRAX

- ▮ KOMTRAX

WA500-6

HORSEPOWER	Gross: 266 kW 357 HP / 1900 min ⁻¹
	Net: 263 kW 353 HP / 1900 min ⁻¹
OPERATING WEIGHT	33220 – 34540 kg
BUCKET CAPACITY	4.3 – 5.6 m ³

HIGH PRODUCTIVITY & LOW FUEL CONSUMPTION



Precision Control with Closed-center Load Sensing System (CLSS) Hydraulics

The WA500-6 features variable-displacement pumps on both the hydraulic and steering systems. These pumps deliver the exact amount of oil required, dramatically improving fuel efficiency. Komatsu's Closed-center load sensing system (CLSS) hydraulics enables extremely precise control of the working gear, and ensures that the bucket, boom and hydraulically driven attachments can all move smoothly at the same time.

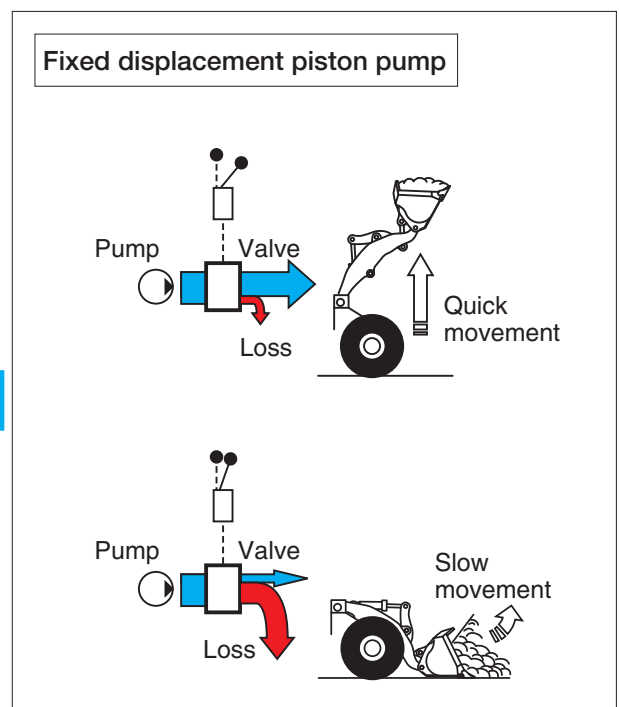
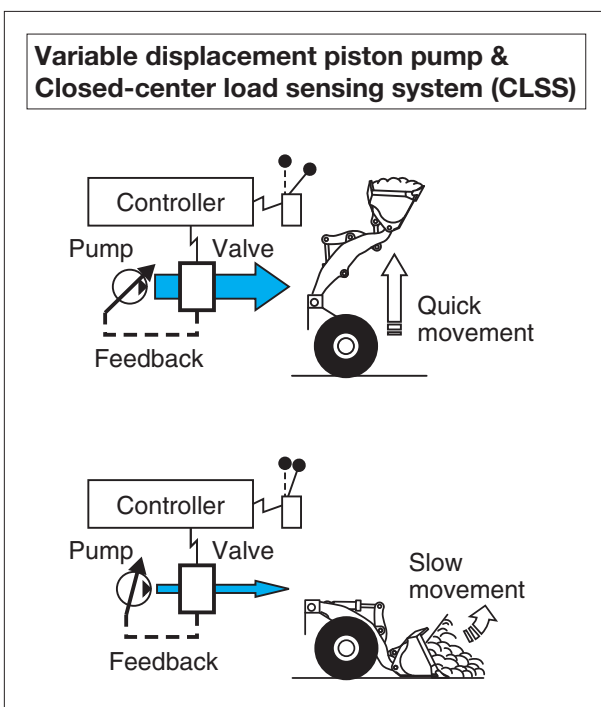

Faster Travel & Lower Fuel Consumption

• Dual-mode Engine Power Select System

This wheel loader offers two selectable operating modes — E and P. The operator can adjust the machine's performance with the selection switch.

- **E Mode:** This mode provides maximum fuel efficiency for general loading.
- **P Mode:** This mode provides maximum power output for hard digging operation or hill climb.

• Automatic Transmission with Mode Select System

This operator controlled system allows the operator to select manual shifting or two levels of automatic shifting (low, and high). Auto L mode is for fuel saving operation with the gear shift timing set at lower speeds than Auto H mode. Therefore Auto L mode keeps the engine in a relatively low rpm range for fuel conservation while yielding adequate tractive force by depressing the accelerator pedal.

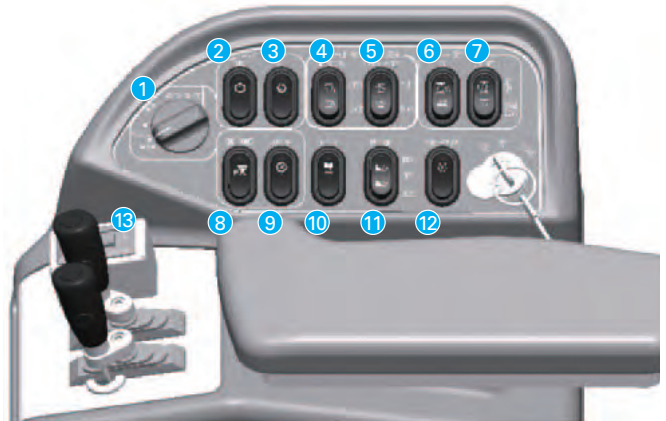

- 1 Transmission auto shift/manual selector switch
- 2 Transmission cut-off switch
- 3 Transmission cut-off set switch
- 4 Remote positioner raise/lower set switch
- 5 Remote positioner bucket angle set switch
- 6 RPM set ON-OFF switch
- 7 RPM set idling up-down selector switch
- 8 Engine power mode selector switch
- 9 Torque converter lockup switch (optional)
- 10 Directional selector ON/OFF switch (optional)
- 11 Semi auto digging switch
- 12 Cooling fan reverse rotation switch
- 13 Directional selector switch (optional)

Advanced Power Train

The newly designed Komatsu power train features a large capacity torque converter for maximum efficiency and unparalleled rimpull to weight ratio. The outstanding rimpull at low speeds makes child's play of heavy job like penetrating blasted rock. This ensures higher productivity in V-shaped loading - even in confined spaces. With plenty of acceleration and high travel speeds (even on inclines and steep ramps), the WA500-6 delivers great productivity and value in load & carry operations. Together, the enhanced engine torque and high-capacity torque converter put the WA500-6 at the top of its class.

• Lock-up Torque Converter (optional)

The Komatsu designed lock-up torque converter provides increased production efficiency, reduced cycle times and optimum fuel savings in load & carry or hill-climb operations. This optional feature allows the operator to activate the system on/off with a switch located on the right-side control panel.



Maximum Dumping Clearance and Reach

The WA500 enables loading onto 32 t (40 Short ton) with the standard spec whereas WA500-6 necessitates the high lift boom with the 4.5 m³ bucket for it. Operator can get good visibility because of high his eye point.



Long Wheelbase/Articulation Angle of 40°

The widest tread in class and the long wheelbase provide improved machine stability in both longitudinal and lateral directions. Since the articulation angle is 40°, the operator can work efficiently even in the tightest job sites.

Tread	2400 mm
Wheelbase	3780 mm
Minimum turning radius (center of outside tire)	6430 mm

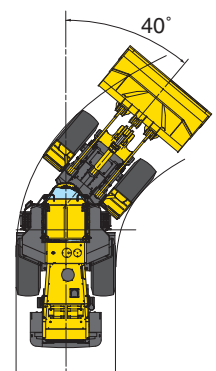

INCREASED RELIABILITY



Komatsu Designed Components

Komatsu develops and manufactures the hydraulic pumps and valves, front and rear axles, engine, transmission and torque converter itself. All the components are subject to the highest engineering and quality standards – right down to the smallest screw. They are all designed to work together perfectly for maximum efficiency and reliability

- **Newly developed transmission**

The Komatsu planetary transmission with electronically controlled automatic shifting ensures a perfect gear change every time. Based on the travel speed, the engine speed and the angle of the accelerator pedal, the system calculates the ideal shifting point to keep the engine in an economical operating range and ensures a smooth gear shift. This guarantees maximum productivity with minimal effort, allowing the operator to concentrate on the job at hand.

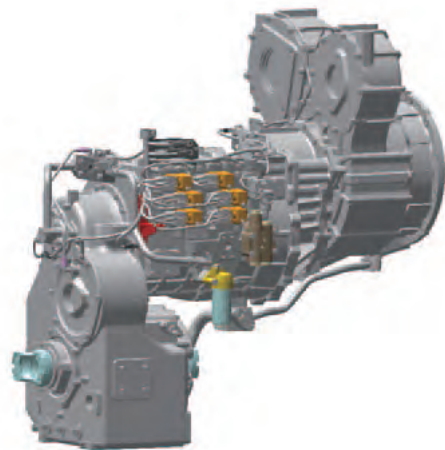

- **Durable, heavy-duty axles**

A new development, the heavy-duty axles enable an above-average service life even under the toughest working conditions. The WA500-6 can also be equipped with optional multi-disc, limited-slip differentials for even greater tractive force.

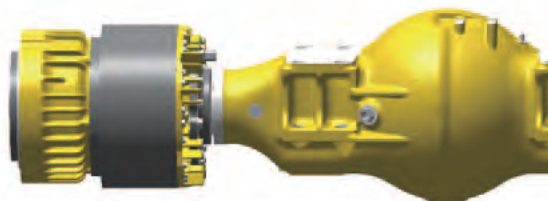

Komatsu Developed Engine

Komatsu SAA6D140E-5 engine with high pressure common rail injection delivers ample power in a fuel efficient way. The engine meets EU Stage IIIA and EPA Tier III emissions regulations. WA500-6's Komatsu SAA6D140E-5 engine features higher torque, better performance at low speed, excellent throttle response and advanced electronics.

- **High Pressure Common Rail (HPCR) fuel injection system**

A high pressure pump pumps fuel into "Common Rail". An Electronic Control Unit (ECU) then optimizes fuel injection from the common rail into the engine cylinders. This improves engine power and fuel efficiency, reducing emission and noise levels.

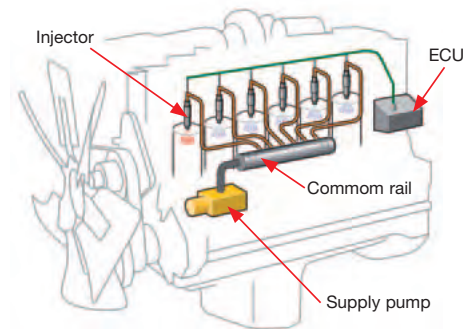

- **Cooled Exhaust Gas Recirculation (EGR) system**

Cooled exhaust gas returned to the cylinders prevents nitrogen and oxygen bonding during combustion, reducing NOx emissions, lowering thermal stress and improving fuel efficiency.

High-rigidity Frames and Loader Linkage

The front and rear frames and the loader linkage have more torsional rigidity to secure resistance against increased stress due to the use of a larger bucket. Frame and loader linkage are designed to accommodate actual working loads, and simulated computer testing proves its strength.

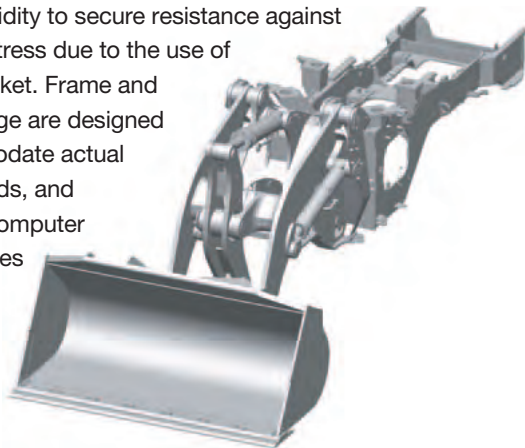

Wet Multiple-disc Brakes and Fully Hydraulic Braking System

Fully sealed wet multiple-disc brakes exert great performance even in the puddles and on soft ground. Added reliability is designed into the two independent braking system with the fully hydraulic circuits. Provides hydraulic backup should one of the circuit fail. There is neither air system to bleed, nor the condensation of water in the system that can lead to contamination, corrosion and freezing.

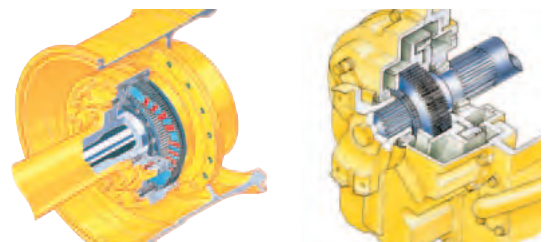

Reliable Hydraulic Line

- **Flat face-to-face o-ring seals**

Flat face-to-face O-ring seals are used to securely seal hydraulic hose connections and to prevent oil leakage.

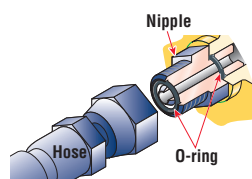

- **Buffer rings**

In addition, buffer rings are installed to the head side of the all-hydraulic cylinders to lower the load on the rod seals and maximize the reliability.

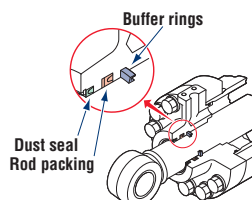

Sealed Connectors

Main harnesses and controller connectors are equipped with sealed connectors providing high reliability, water resistance and dust resistance.



EXCELLENT OPERATOR ENVIRONMENT



The largest in its class, the space cab offers exceptional driver's comfort - comparable to a passenger car. The large, frameless window gives an unobstructed view of the bucket and tires while the slanted rear end ensures a clear view to the rear. The low-noise designed cab with the air-cushioned seat and the fully adjustable console inside allow the operator to work comfortably and productively over long period.

Pillar-less Large Cab

A wide pillar-less flat glass provides excellent front visibility. The wiper arm covers a large area to provide great visibility even on rainy days. The cab area is the largest in its class providing maximum space for the operator. Increased seat slide adjustment to backward by introducing front mounted air conditioner unit.



Low-noise Design

The large cab is mounted with Komatsu's unique ROPS/FOPS (ISO 3471/ISO 3449) viscous mounts. The low-noise engine, hydraulically driven fan, and hydraulic pumps are mounted with rubber cushions, and the cab sealing is improved to provide a quiet, low-vibration, dustproof with pressurizing, and comfortable operating environment.



Best Position for Comfort

• Telescopic/Tilt steering column

The operator can tilt and telescope the steering column to provide a comfortable working position.

- ① Tilt adjustment
- ② Telescopic adjustment



• Ergonomic hydraulic controls and large armrest

The Electronic Pilot Control (EPC) levers offer precise, fatigue-free control of the loading process. The height of and distance to the sliding console and the large armrest can be adjusted for maximum comfort.



Automatic Transmission

Automatic transmission with Electronic Controlled Modulation Valve selects automatically the proper gear speed based on travel speed, engine speed and other travel condition. The Electronic Controlled Modulation Valve system engages the clutch smoothly to prevent lags and shocks when shifting, allowing the operator to be released from gear shift operation itself.

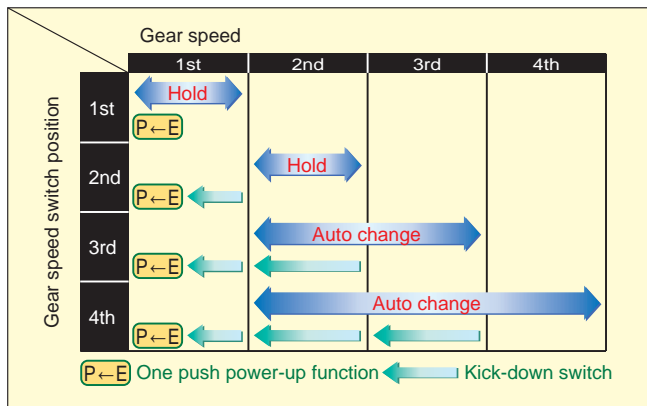

- **Hold switch**

Auto shift is selected and if the operator turns on this switch when the lever is at the 3rd or 4th gear speed position, the transmission is fixed to that gear speed.

- **Kick-down switch**

The kick-down switch downshifts to a lower gear when the operator pushes the switch. Gear position is automatically reset when putting the gear into reverse.



- **One push power-up**

The kick-down switch allows to increase power temporarily in E mode. In the 1st gear with E mode, pressing the kick-down switch changes the mode to P mode. Useful for heavy digging operation during light application such as Load & Carry operation.

- **Variable transmission cut-off**

The operator can adjust the transmission cut-off connected to the left brake pedal with the switch near the operator's seat to set the brake/cut-off point for easier operation and higher operating performance in variable operating conditions.

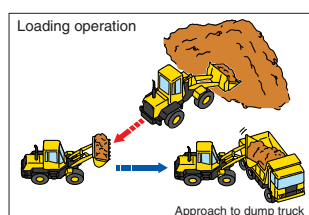
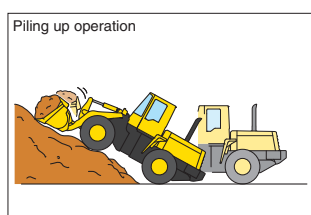

Easy & Simple Operation

- **Remote boom positioner**

The highest and lowest position of the bucket can be set from cab to match any truck body. Once the positioner is set, the bucket is smoothly stopped at desired position with no shock.

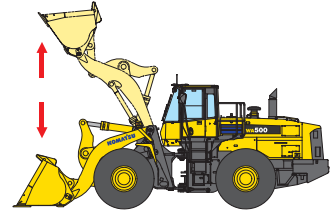

- **Remote bucket digging angle control**

The bucket return-to-dig angle can be adjusted by up to 5 degrees in either direction to suit the ground condition.

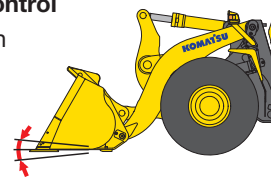

- **Automatic boom & bucket kick-out**

The kick-out positions can be adjusted from the operator's seat, stopping lifting and lowering actions smoothly at the desired point so the operator can focus on the job at hand.

Option

- **Joystick steering**

A joystick steering system is available as option equipment, and ensures that steering can be wrist operated easily and conveniently in loading operations. This system allows you to change the direction of travel and gear shifting with push buttons on the joystick. And you may pre-select the steering speed in 2 stages, depending upon whether fast V-loading or precise Load & Carry is required.



- **Electronically Controlled Suspension System (ECSS)**

Electronically Controlled Suspension System uses an accumulator which absorbs some of the shock in the boom arm, giving the operator a much smoother ride. This reduces operator fatigue and reduces material spillage during load and carry operations. Electronically Controlled Suspension System operation is speed sensitive and turned off automatically below 5 km/h speed, meaning that the boom won't move during stationary digging.

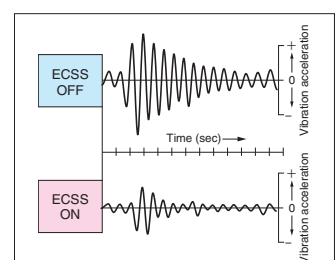

* Image is for illustration purpose

EASY MAINTENANCE



With long service intervals and best-in-class accessibility, the WA500-6 reduces the time and money you need to suspend on maintenance. A gas spring helps the operator open and close each gull-wing side door for easy daily servicing.

Easy Radiator Cleaning

- **Reversible hydraulic fan**

A push-button switch in the cab allows the operator to run the radiator fan in reverse for working in dusty environments.

- **Swing out fan**

The hinged, bolt-on fan can be swung out for easier cleaning. The coolers feature wider spacing of the cooling fins to reduce clogging.



- **Simple fluid level checks**

All important fluid levels can be easily checked from ground level. Sight gauges for coolant, oil and air cleaner let you check the level at a glance.

- **Modular radiator core system**

The modular radiator core is easy to replace without removing the entire radiator assembly.

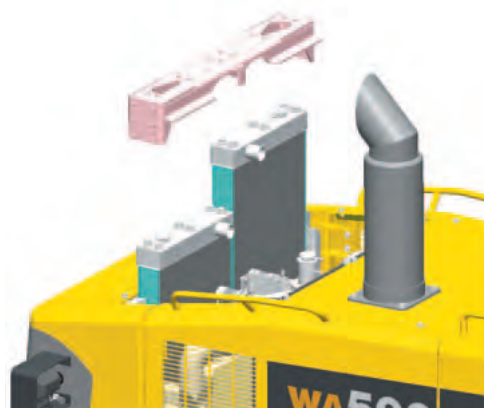

Equipment Management Monitoring System

Monitor is mounted in front of the operator for easy viewing, allowing the operator to easily check gauges and warning lights. A specially designed two-spoke steering wheel allows the operator to easily see the instrument panel.

Maintenance Control and Troubleshooting Functions

- **Action code display function**

If abnormality occurs, the monitor displays action details on the character display at the bottom center of the monitor.

- **Monitor function**

Controller monitors engine oil level, pressure, coolant temperature, air cleaner clogging, etc. If controller finds abnormalities, the error is displayed on Liquid Crystal Display (LCD).

- **Replacement time notice function**

Monitor informs replacement time of oil and filters on LCD when replacement intervals are reached.

- **Trouble data memory function**

Monitor stores abnormalities for effective troubleshooting.



- ① Engine coolant temperature gauge
- ② Speedometer or tachometer
- ③ Hydraulic oil temperature gauge
- ④ Fuel Gauge
- ⑤ Torque converter oil temperature gauge
- ⑥ Character display
- ⑦ Inspection and maintenance items pilot lamp

Maintenance Accessibility

- **Gull-wing type engine side doors open wide**

The operator can open and close each gull-wing type engine side door easily with the assistance of a gas spring to perform daily service checks from the ground.

- **Engine compartment**

With all filters collected into a centralised arrangement, the down time for servicing is reduced to a minimum. The engine air filter can be easily accessed from the platform while the transmission oil filters are externally mounted.



- **Easy engine access**

For engine inspections, the bolt-on top cover can be removed in minutes providing the easy access to the engine compartment.

- **External fluid drains**

All fluids can be drained through externally mounted valves for easy maintenance and reduced spillage.

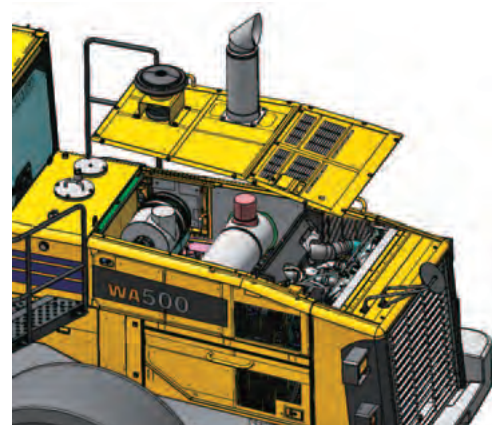



ROPS/FOPS Cab

The ROPS/FOPS Cab is standard for operator's safety. A wide pillar-less flat glass provides excellent front visibility, and a heated rear window provides excellent rear visibility in cold and freezing weather conditions.

ROPS (ISO 3471) : Roll-over Protective Structure

FOPS (ISO 3449) : Falling Objects Protective Structure



Rear-hinged Full Open Cab Door

The cab door hinges are installed to the rear side of the cab providing a large opening angle for the operator to enter and exit. The steps are designed like a staircase, so that the operator can get on and off the cab easily.



Left or Right Side Cab Entry

The operator can get on and off the machine from either side of the vehicle. This design is convenient when getting on and off in a narrow jobsite or on uneven ground.

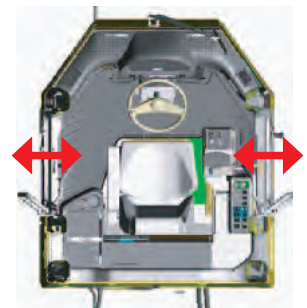

Safety Features

- **Secondary steering**
If the steering pump is disabled, a secondary steering pump provides hydraulic flow.
- **Two independent lines brake system**
Added reliability is designed into the braking system by the use of two independent hydraulic circuits, providing hydraulic backup should one of the circuits fail.
- **Battery disconnect switch**
The battery disconnect switch is located in the right side battery box. This can be used to disconnect power when performing service work on the machine.

KOMTRAX

The Komatsu remote monitoring and management technology provides insightful data about your equipment and fleet in user-friendly format.

Energy Saving Operation Report

KOMTRAX delivers the energy-saving operation report based on the operating information such as fuel consumption, load summary and idling time, which helps you efficiently run a business.



This report image is an example of hydraulic excavator

Equipment Management Support

Through the web application, a variety of search parameters are available to quickly find information about specific machines based on key factors. Moreover, KOMTRAX finds out machines with problems from your fleet and shows you through an optimal interface.

Location

Working status

Periodic maintenance

The report contents and data depend on the machine model.

Optimal Strategy for Efficient Work

The detailed information that KOMTRAX puts at your fingertips helps you manage your fleet conveniently on the web anytime, anywhere. It gives you the power to make better daily and long-term strategic decisions.

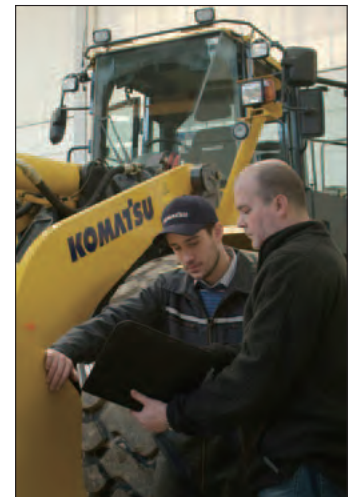



DIMENSIONS

Measured with 29.5-25-22PR (L-3) tires

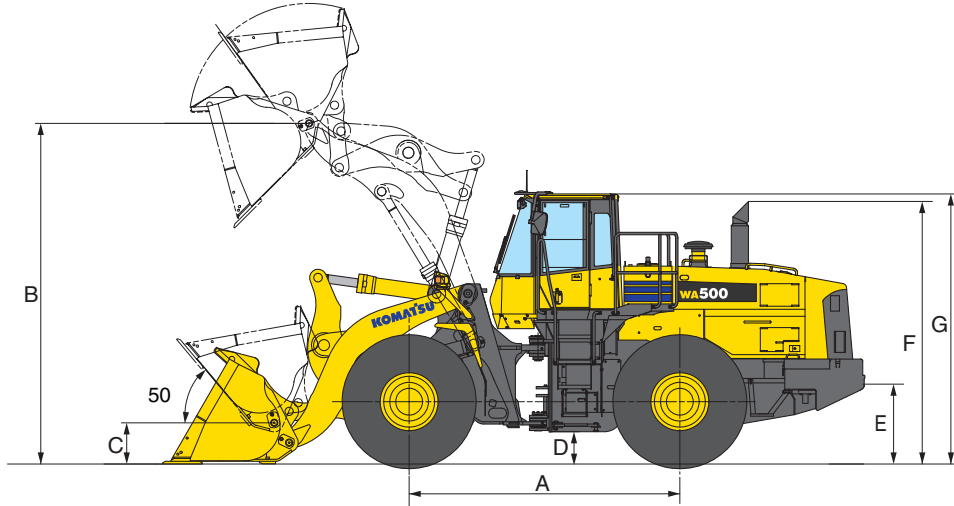

	Standard Boom	High Lift Boom
Tread	2400 mm	
Width over tires	3190 mm	
A Wheelbase	3780 mm	
B Hinge pin height, max. height	4755 mm	5165 mm
C Hinge pin height, carry position	575 mm	700 mm
D Ground clearance	450 mm	
E Hitch height	1115 mm	
F Overall height, top of the stack	3665 mm	
G Overall height, ROPS cab	3785 mm	

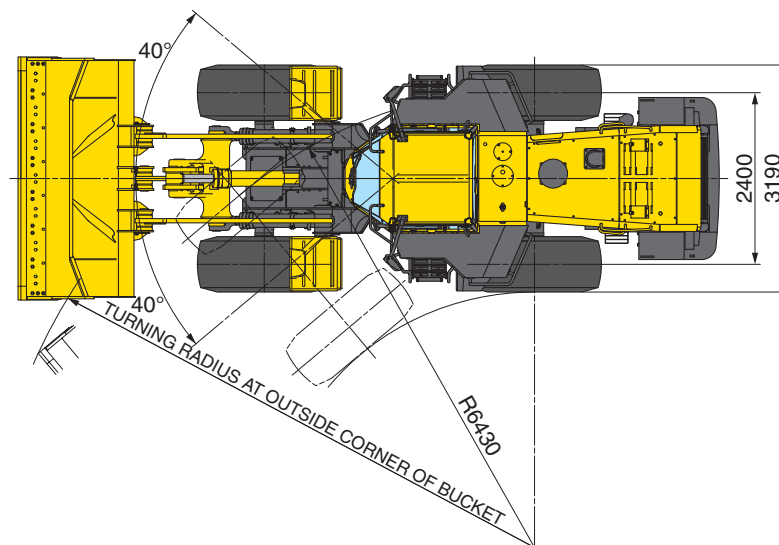



DIMENSIONS

Measured with 29.5-25-22PR (L-3) tires

Standard Boom		Stockpile Bucket		Excavating Bucket			Rock Bucket (Spade nose)	
		B.O.C.	Teeth	B.O.C.	Teeth and Segments	Teeth	Teeth and Segments	Teeth
Bucket capacity:	heaped	5.6 m ³	5.3 m ³	5.2 m ³	5.2 m ³	5.0 m ³	5.0 m ³	4.7 m ³
	struck	4.8 m ³	4.5 m ³	4.2 m ³	4.2 m ³	4.0 m ³	4.2 m ³	4.0 m ³
Bucket width		3400 mm	3460 mm	3400 mm	3460 mm	3460 mm	3460 mm	3460 mm
Bucket weight		3110 kg	2955 kg	3055 kg	3145 kg	2900 kg	3745 kg	3490 kg
Dumping clearance, max. height and 45° dump angle*		3295 mm	3165 mm	3395 mm	3265 mm	3265 mm	3030 mm	3030 mm
Reach at max. height and 45° dump angle*		1500 mm	1600 mm	1400 mm	1495 mm	1495 mm	1725 mm	1725 mm
Reach at 2130 mm clearance and 45° dump angle		2300 mm	2340 mm	2215 mm	2285 mm	2285 mm	2400 mm	2400 mm
Reach with arm horizontal and bucket level		3265 mm	3425 mm	3120 mm	3280 mm	3280 mm	3610 mm	3610 mm
Operating height (fully raised)		6430 mm	6430 mm	6415 mm	6415 mm	6415 mm	6630 mm	6630 mm
Overall length		9815 mm	9975 mm	9670 mm	9790 mm	9790 mm	10155 mm	10155 mm
Loader clearance circle (bucket at carry, outside corner of bucket)		15300 mm	15460 mm	15220 mm	15380 mm	15380 mm	15290 mm	15290 mm
Digging depth:	0°	135 mm	155 mm	135 mm	155 mm	155 mm	165 mm	165 mm
	10°	435 mm	485 mm	410 mm	460 mm	460 mm	525 mm	525 mm
Static tipping load:	straight	24440 kg	24640 kg	24590 kg	24480 kg	24795 kg	23840 kg	24160 kg
	40° full turn	21120 kg	21290 kg	21250 kg	21155 kg	21425 kg	20600 kg	20875 kg
Breakout force		245 kN	262 kN	268 kN	274 kN	288 kN	233 kN	243 kN
Operating weight		33430 kg	33275 kg	33375 kg	33465 kg	33220 kg	34065 kg	33810 kg

High Lift Boom		Excavating Bucket		
		B.O.C.	Teeth and Segments	Teeth
Bucket capacity:	heaped	4.5 m ³	4.5 m ³	4.3 m ³
	struck	3.7 m ³	3.7 m ³	3.5 m ³
Bucket width		3400 mm	3460 mm	3460 mm
Bucket weight		2885 kg	2975 kg	2730 kg
Dumping clearance, max. height and 45° dump angle*		3890 mm	3760 mm	3760 mm
Reach at max. height and 45° dump angle*		1435 mm	1530 mm	1530 mm
Reach at 2130 mm clearance and 45° dump angle		2585 mm	2645 mm	2645 mm
Reach with arm horizontal and bucket level		3385 mm	3545 mm	3545 mm
Operating height (fully raised)		6715 mm	6715 mm	6715 mm
Overall length		10030 mm	10190 mm	10190 mm
Loader clearance circle (bucket at carry, outside corner of bucket)		15610 mm	15780 mm	15780 mm
Digging depth:	0°	210 mm	235 mm	235 mm
	10°	470 mm	520 mm	520 mm
Static tipping load:	straight	22545 kg	22430 kg	22735 kg
	40° full turn	19480 kg	19380 kg	19645 kg
Breakout force		286 kN	294 kN	310 kN
Operating weight		34450 kg	34540 kg	34295 kg

* At the end of tooth or bolt on cutting edge (B.O.C.).

All dimensions, weights, and performance values based on ISO 7131 and 7546 standards.

Static tipping load and operating weight shown include lubricant, coolant, full fuel tank, ROPS cab, Air conditioner and operator. Machine stability and operating weight affected by counterweight, tire size, and other attachments. Apply the following weight changes to operating weight and static tipping load.



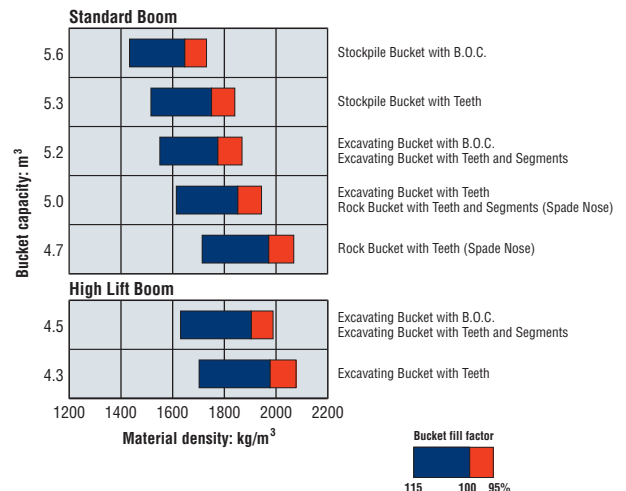

BUCKET SELECTION GUIDE





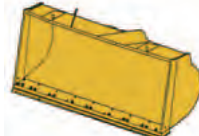

BUCKETS & ATTACHMENTS

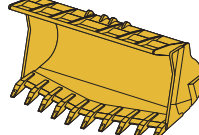
■ **Buckets**

Type	Feature	Image
Stockpile Bucket	This bucket is used for loading stockpile products, such as crushed rock and construction materials.	
Excavating Bucket	This bucket is used for excavating and loading blasted rock on rock crushing job sites, or for excavating natural ground. It has a flat-blade, straight cutting edge, and provides superior rigidity and wear resistance.	
Rock Bucket (Spade nose)	This bucket is used for excavating and loading blasted rock on rock crushing job sites. It has a pointed cutting edge, and provides superior rigidity and wear resistance.	

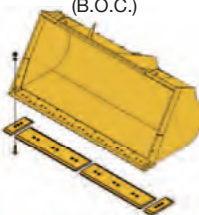
■ **Cutting Edges and Teeth**

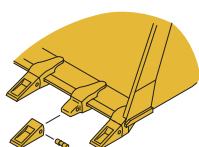
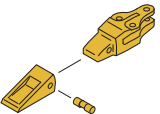
Type	Feature	Image	
Cutting Edges	This edge is made for use in loading loose sand and soil, or for loading stockpiled materials. It is bolted to the leading edge of general purpose buckets and may be detached and reversed. The cutting edges are manufactured from especially heat treated, high tension steel, and since they are reversible, both edges can be used. This effectively doubles their working life.	Bolt on Cutting edges (B.O.C.) 	Segment Edges (SE) 
Teeth (Bolt on type)	These teeth are suitable for loading or excavation of piles of earth or sand, blasted rock, and jobs in the field that involve digging into the side of slopes. The special heat treated, tensile strength steel alloy used in their production assures that they will wear and have a long service life.		
Teeth (Tip type)	These teeth tips which are attached to an adapter that is welded or bolted to the bucket edge. This means that an interchangeable part, the tooth tip, absorbs most of the wear and protects the actual bucket edge. They give excellent performance when used to handle blasted rock, piles of earth and similarly heavy duty tasks.	Welded adapter 	Bolt on adapter 



WEIGHT / DIMENSIONS

Tires or attachments	Change in operating weight	Change in tipping load straight	Change in tipping load full turn	Width over tires	Ground clearance	Change in vertical dimensions
	kg	kg	kg	mm	mm	mm
29.5-25-22PR (L-3)	0	0	0	3190	450	0
29.5-25-22PR (L-5)	1335	1135	995	3190	450	0
29.5-R25 (L-3)	10	5	5	3190	450	0
29.5-R25 (L-5)	1530	1295	1135	3190	450	0
Install additional counterweight	900	1865	1645			



STANDARD EQUIPMENT

ENGINE/POWER TRAIN:

- Engine, Komatsu SAA6D140E-5 diesel
- Engine pre-cleaner with extension
- Service brakes, wet disc type
- Transmission, 4 forward and 4 reverse

ELECTRICAL SYSTEM:

- Alternator, 75 A/24 V
- Back-up alarm
- Back-up lamp
- Batteries, 2 x 12 V/170 Ah
- Directional signal
- Engine shut-off system, electric
- Starting motor, 24 V/11.0 kW

HYDRAULIC SYSTEM:

- 2-spool valve for boom and bucket controls
- Hydraulic-driven fan with reverse rotation
- Lift cylinders and bucket cylinder

CAB:

- Air conditioner
- Auto shift transmission with mode select system
- Electronic Pilot Control fingertip control levers with automatic leveler and positioner
- Floor mat
- Main monitor panel with Equipment Management Monitoring System
- Rearview mirror for cab
- Rear window washer and wiper
- ROPS/FOPS (ISO 3471/ISO 3449) cab
- Seat, air-suspension type with reclining
- Seat belt
- Steering wheel, tiltable, telescopic
- Sun visor

WORK EQUIPMENT:

- Counterweight

OTHER EQUIPMENT:

- Front fender
- Hard water area arrangement (corrosion resister)
- Radiator mask, lattice type
- Rear under view mirror
- Tires (29.5-25-22PR, L-3 tubeless) and rims
- Vandalism protection kit



OPTIONAL EQUIPMENT

ENGINE/POWER TRAIN:

- Brake cooling system
- Limited slip differential (F&R)

ELECTRICAL SYSTEM:

- 12 V converter
- Alternator, 90 A/24 V
- Batteries, 2 x 12 V/220 Ah
- Battery disconnect switch

HYDRAULIC SYSTEM:

- In-line filter
- Lock-up clutch torque converter

CAB:

- AM/FM radio
- AM/FM stereo radio cassette
- Cab heater and defroster
- FNR directional change switch
- Joystick steering
- Seat, air suspension with automatic weight adjustment
- Secondary steering (ISO 5010)

WORK EQUIPMENT:

- Additional counterweight
- Bucket teeth (bolt on type)
- Bucket teeth (tip type)
- Cutting edge (bolt on type)
- High lift boom
- Segmented edges

OTHER EQUIPMENT:

- Electronically Controlled Suspension System
- Fire extinguisher
- Fuel quick coupler
- Load meter, new type
- Ordinary spare parts
- Power train guard
- Tool kit

KOMATSU TOTAL SUPPORT**Komatsu Total Support**

To keep your machine available and minimize operation cost when you need it, Komatsu Distributor is ready to provide a variety of supports before and after procuring the machine.

Fleet recommendation

Komatsu Distributor can study the customer's job site and provide the most optimum fleet recommendation with detailed information to meet all of your application needs when you are considering to buy new machines or replace the existing ones from Komatsu.

Product support

Komatsu Distributor gives the proactive support and secures the quality of the machinery that will be delivered.

Parts availability

Komatsu Distributor is available for emergency inquiry by the customers for genuine, quality guaranteed Komatsu parts.

Technical support

Komatsu product support service (Technical support) is designed to help customer. Komatsu Distributor offers a variety of effective services to show how much Komatsu is dedicated to the maintenance and support of Komatsu machine.

- Preventive Maintenance (PM) clinic
- Oil & Wear analysis program

Repair & maintenance service

Komatsu Distributor offers quality repair and maintenance service to the customer, utilizing and promoting Komatsu developed programs.

Komatsu Reman (Remanufactured) components

Komatsu Reman products are the result of the implementation of the Komatsu global policy which establishes and agrees to reduce the owning, operating and total Life Cycle Costs (LCC) to Komatsu's customer through high quality, prompt delivery and competitively priced in own remanufactured products (QDC).



